



# New Products 2022





## Digimar 817 CLT: Easy measurements using intuitive touch control



### Best connection for secure data

Data can be transferred wirelessly or via USB cable via the MarConnect interface. Quickly print out a series of measurements? A Bluetooth printer is available for this purpose. Simply choose between complete measuring records in PDF format or save your measuring records as a TXT file.



### Interfaces for dial indicators

An interface integrated in the slide enables the error-free measurement of the perpendicularity and straightness using the new Millimes 2000/2001W dial comparators.



### Ergonomics that can be measured

Ergonomics means that the methods, processes, and arrangement are designed for people and not the other way around. This is exactly what the new Digimar 817 CLT stands for: The simple moving and scrolling functions of the touchscreen work just like smartphone and tablet. The keys on the display are already arranged in such a way that frequently used functions are particularly easy to access. The measurements on the measuring slide can easily be started by hand via the touch display, the thumbwheel with integrated arrow keys, or using Quick mode. Two pushbuttons to actuate the air bearings are integrated into the handle enabling the device to be guided safely and sensitively by left- and right-handed operators. Regardless of whether you prefer to sit or stand while working: The touch display is always at eye level and can be rotated and tilted as required. This ensures the measuring process is particularly comfortable and relaxed.





### Simple touch measurement

Intuitive operation via large, clearly defined keys to ensure the safe completion on measurements, setting and calculation of functions, and the creation of measuring programs via Drag & Drop.

### Pivoting display

10-inch touch panel with turn/tilt joint so that it can be set individually for the work position, height of the operator, and lighting conditions.



### Easy handling

The thumbwheel can be used to move the measuring slide quickly and easily start the measurement. The quick measurement function keys also automatically detect surfaces and bores.



### Best ergonomics

Ergonomic handles on both sides have an integrated operating key for the air bearing ensuring the device can be moved accurately and effortlessly on the measuring plate.



# Digimar 817 CLT

Height measuring instrument



## FEATURES

### Operating and display unit

- Large and clearly defined touch display with backlighting
- Operator guidance with self-explanatory icons
- Multilingual user guidance
- Option of setting additional zero points on the workpiece
- Additional measuring instrument can be connected via MarConnect USB port
- Future-proof thanks to software updates
- Automatic activation of standby mode
- Selectable auto-off function, without loss of measured values



### Functions

- Top or bottom contacting
- Web width or distances between grooves, including center of web or groove
- Bore or shaft diameter, including center of bore or shaft
- Bore reversing point (up or down)
- Shaft reversing point (up or down)
- Calculating distances or symmetry
- Dynamic measuring functions
- Perpendicularity measurement
- Straightness measurement
- Measurement in 2D mode
- Measuring programs
- Measuring data processing

### Measuring system

- Optical incremental measuring system for outstanding measuring accuracy and reliability
- Dynamic probe system enabling high repeatability
- Air bearing system for light and smooth movement
- Motorized measuring slide simplifies measurement runs
- Probe constant remains after the instrument is switched off
- Integrated rechargeable battery with a long operating life for mains-independent measurement
- Temperature compensation via internal temperature sensor

### Scope of delivery

- Height measuring instrument incl. operating and display element
- Carrier 817 h1
- Measuring anvil K6/51
- Setting gage 817 eb
- USB cable
- Operating instructions
- Recharging unit
- Protective cover
- Calibration certificate

## TECHNICAL DATA

Order no.	4429600	4429601	4429602
Product type		817 CLT	
Measuring range	mm 0 – 350	0 – 600	0 – 1000
Application range from	mm	170	
Application range up to	mm 520	770	1170
Resolution	mm	0.01, 0.005, 0.001, 0.0005, 0.0001	
Resolution	inch	.001", .0005", .0001", .00005", .00001"	
Error limit	µm	(1.8 + L/600) L in mm	
Repeatability bores	µm	1	
Repeatability planes	µm	0.5	
Perpendicularity error in µm	µm	5	6 10
Operating time max.	h	14	
Measuring force	N	1.0 +/- 0.2 N	
Relative humidity non-condensing	%	65	
Working temperature	°C	20	
Operating temperature	°C	10 – 40	
Product weight	kg	22	26 29
Data interface		USB, Wireless	
Standard		Factory standard	

## ACCESSORIES

Order no.	Product name	Product type
6910271	Printer set incl. Bluetooth USB adapter	DP-B1
4102220	USB adapter for MarConnect Wireless	i-stick
4221525	Surface plate made from granite, 1000 x 630 mm	107 G
5450105	Printer paper, 12 rolls	
4221573	Stand, 1000 x 630 mm	107 Ug
4221526	Surface plate made from granite, 1200 x 800 mm	107 G
4221574	Stand, 1200 x 800 mm	107 Ug

### Software

- MarCom Professional can be downloaded free of charge from: [www.mahr.com/marcom](http://www.mahr.com/marcom) (only for Mahr data cable and wireless systems with USB and RS-232 interface)



i-Stick



107 G + 107 Ug



DP-B1

# Digimar 817 ts1

## Probe set

### FEATURES

- Large accessory kit
- Packaged in a practical plastic case
- Consisting of:
  - Depth probe
  - Carrier with extended holder
  - Disc measuring probe for grooves, etc.
  - Conical measuring probe
  - Cylindrical measuring probe
  - Holder for test indicator styli with M2 thread
  - Carrier including 4 spherical probes with shaft diameter 8 mm
- Package contains: case



### TECHNICAL DATA

Order no.	Product type
4429019	817 ts1

### COMPONENTS INCLUDED IN SET

Order no.	Product name	Product type
4429219	Carrier for a probe, mounting hole 6 mm, a = 100.5 mm, b = 119.5 mm, c = 84 mm	817 h2
4429226	Disc probe $\varnothing$ 15 mm	S 15/31.2
4429227	Cylindrical probe $\varnothing$ 10 mm	Z 10/31.2
4429228	Taper probe	MKe 30
4429221	Depth probe incl. Holder	TMT 120
4429256	Probe with M2 threads for 3 styli positions ( $0^\circ/10^\circ/90^\circ$ ), incl. styli 800 ts $\varnothing$ 2.0 mm	KM 2
4429220	Carrier for probes 817 CLM, mounting hole 8 mm	817 h4
7023813	Probe with mount, $\varnothing$ 4.0 mm	K 4/30
7023816	Probes with mount, $\varnothing$ 6 mm	K 6/40
7023810	Probes with mount, $\varnothing$ 10.0 mm	K 10/60
7023615	Probes with mount, $\varnothing$ 10.0 mm	K 10/100

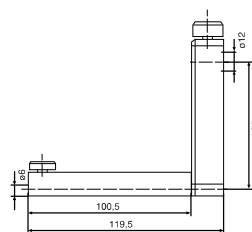

817 h2

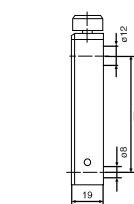

817 h4

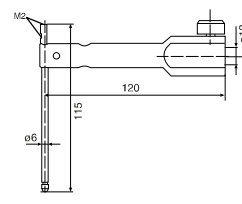

TMT 120

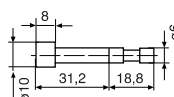

Z 10/31.2

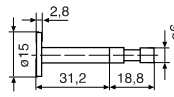

S 15/31.2

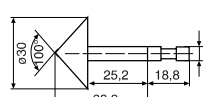

MKe 30

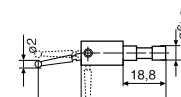

KM 2

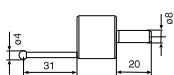

K 4/30



K 6/40



K 10/60

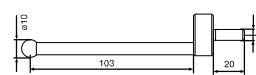

K 10/100

# Digimar 817 ts2

## Probe set

### FEATURES

- Small accessory kit
- Packaged in a practical plastic case
- Consisting of:
  - Depth probe
  - Carrier with extended holder
  - Disc measuring probe for grooves, etc.
  - Conical measuring probe
  - Cylindrical measuring probe
  - Holder for test indicator styli with M2 thread
- Package contains: case



### TECHNICAL DATA

Order no.	Product type
4429018	817 ts2

### COMPONENTS INCLUDED IN SET

Order no.	Product name	Product type
4429219	Probe carrier, mounting hole 6 mm, a = 100.5 mm, b = 119.5 mm, c = 84 mm	817 h2
4429226	Disc probe $\varnothing$ 15 mm	S 15/31.2
4429227	Cylindrical probe $\varnothing$ 10 mm	Z 10/31.2
4429228	Taper probe	MKe 30
4429221	Depth probe including holder	TMT 120
4429256	Probe incl. styli 800 ts $\varnothing$ 2.0 mm	KM 2

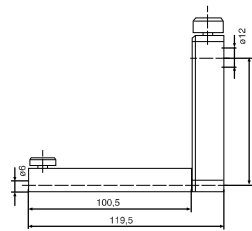

817 h2

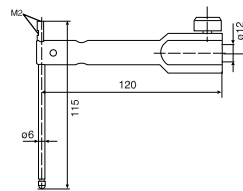

TMT 120

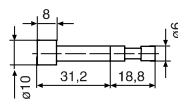

Z 10/31.2

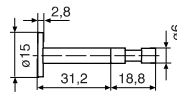

S 15/31.2

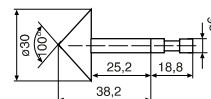

MKe 30

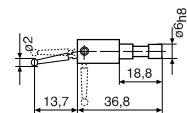

KM 2



# Digimar 817 ts3

## Universal probe set

### FEATURES

- Accessory kit for small parts and delicate grooves, recesses and bores
- Packaged in a practical wooden case
- Suitable for 817 h4 carriers with 8 mm mounting bore
- Consisting of:
  - Base with 8 mm holding shaft
  - Depth probe
  - Probe shoe for grooves and recesses
  - Spherical measuring probe
  - Conical measuring probe
  - Extension
  - Adapter for M2.5 measuring anvils
- Package contains: case



### TECHNICAL DATA

Order no.	Product type
7034000	817 ts3

### COMPONENTS INCLUDED IN SET

Order no.	Product name	Product type
3015917	Probe carrier	GK/8
3015918	Measuring crook, $d = 0.5 \text{ mm}$ , $l = 78 \text{ mm}$	TS 0.5/78
3015919	Probe pin/tip, $d = 1.2 \text{ mm}$ , $l = 75 \text{ mm}$ , $l_s = 15.5 \text{ mm}$	T 1.2/75
3015920	Taper probe	MKe 8
3022000	Spherical probe, $d_k = 3.0 \text{ mm}$ , $l = 24 \text{ mm}$	K 3/24
3022001	Spherical probe, $d_k = 2.0 \text{ mm}$ , $l = 24 \text{ mm}$	K 2/24
3022002	Spherical probe, $d_k = 1.0 \text{ mm}$ , $l = 24 \text{ mm}$	K 1/24
3015888	Extension M3 - M2.5, $d = 4 \text{ mm}$ , $l = 20 \text{ mm}$	V/M 2.5
3015921	Extension M3 - M3, $d = 4 \text{ mm}$ , $l = 20 \text{ mm}$	V/M 3

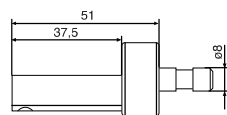

GK/8

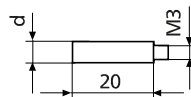

V/M2...M3

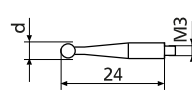

K 1...K3/24

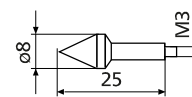

Mke 8

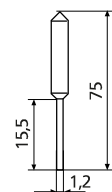

T 1.2/75

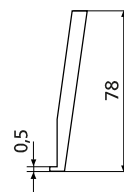

TS 0.5/78



# Digimar 817 h1 / 817 h2 / 817 h5

## Probe carriers

### FEATURES

- Carrier for probes with 6 mm holding shaft
- Used for measurements at increased measuring depth (817 h2)
- Pivoting (817 h5) e.g. for aligning a cylindrical measuring probe



### TECHNICAL DATA

Order no.	Product type
4429154	817 h1
4429219	817 h2
4429454	817 h5

Order no.	a	b	c	Mounting hole
	mm	mm	mm	
4429154	27.5	46.5	84	6 mm
4429219	100.5	119.5	84	6 mm
4429454	35	54	86	6 mm

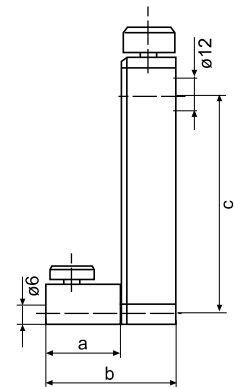

### ACCESSORIES

Order no.	Product name	Product type
4301865	Mounting shaft $\varnothing$ 6 mm for touch probes	800 a6
4429158	Spherical probe, $\varnothing$ 5.0 mm	K 5/51
4429226	Disc probe $\varnothing$ 15 mm	S 15/31.2
4429227	Cylindrical probe $\varnothing$ 10 mm	Z10/31.2
4429228	Taper probe	MKe 30
4429254	Spherical probe for 817 CLM, $\varnothing$ 6 mm	K 6/51
4429256	Probe including styli 800 ts $\varnothing$ 2.0 mm	KM 2

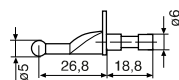

K 5/51

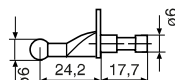

K 6/51

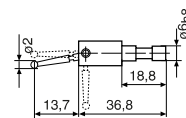

KM 2

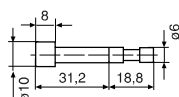

Z 10/31.2

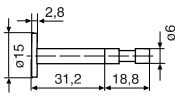

S 15/31.2

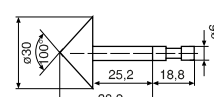

MKe 30

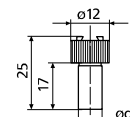

800 a6

# Digimar 817 h4

## Probe carriers 817 CLM

### FEATURES

- Carrier for measuring anvils with 8 mm holding shaft and weighing 102 g
- Suitable for the CXt2 universal measuring probe set
- Compatible with Digimar CX1 and CX2 probes weighing 102 g



### TECHNICAL DATA

Order no.	Product type	Mounting hole
4429220	817 h4	8 mm

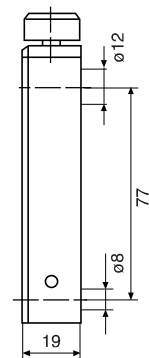

### ACCESSORIES

Order no.	Product name	Product type
3015888	Extension M3 - M2.5, d = 4 mm, l = 20 mm	V/M 2.5
3015917	Probe carrier	GK/8
3015918	Measuring crook, d = 0.5 mm, l = 78 mm	TS 0.5/78
3015919	Probe pin/tip, d = 1.2 mm, l = 75 mm, ls = 15.5 mm	T 1.2/75
3015920	Taper probe	MKe 8
3015921	Extension M3 - M3, d = 4 mm, l = 20 mm	V/M 3
3022000	Spherical probe, d <sub>k</sub> = 3.0 mm, l = 24 mm	K 3/24
3022001	Spherical probe, d <sub>k</sub> = 2.0 mm, l = 24 mm	K 2/24
3022002	Spherical probe, d <sub>k</sub> = 1.0 mm, l = 24 mm	K 1/24
7023615	Probes with mount, ø 10.0 mm	K 10/100
7023810	Probes with mount, ø 10.0 mm	K 10/60
7023813	Probe with mount, ø 4.0 mm	K 4/30
7023816	Probes with mount, ø 6 mm	K 6/40

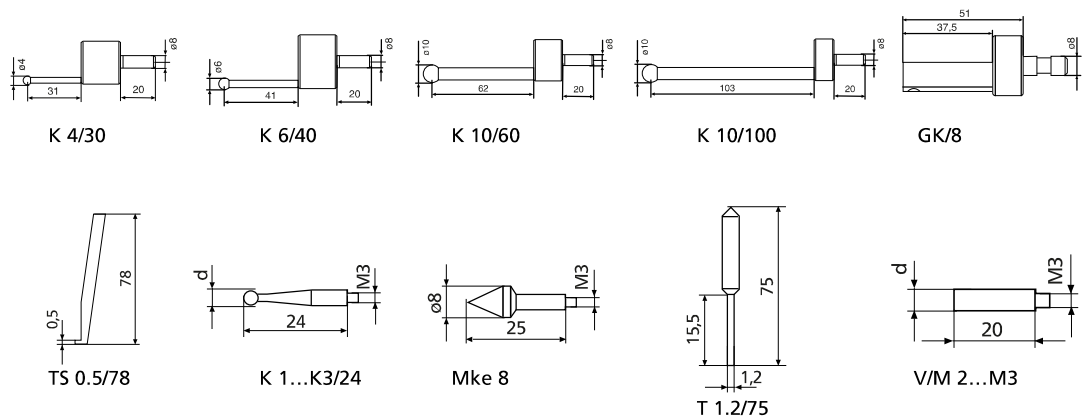

# Digimar TMT 120 / TMT 120 S

## Depth probe including holder

### FEATURES

- Depth probe and carrier for measurements in vertical bores and recesses
- Interchangeable depth probe
- M2 and M2.5 connecting threads for measuring anvils
- M2.5 spherical contact point
- 901 H
- pivoting (TMT 120 S only)
- Second depth probe with probe shoe for groove measurement (TMT 120 S only)
- M2 stylus 800 ts with 2 mm ball (TMT 120 S only)

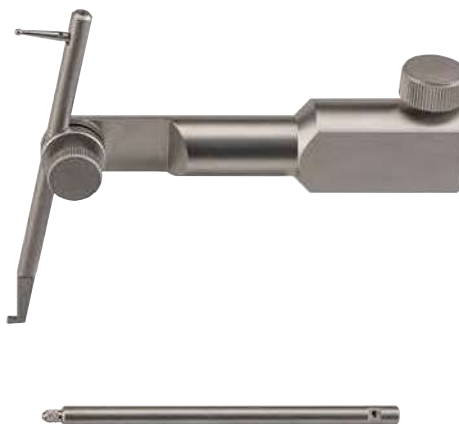

### TECHNICAL DATA

Order no.	Product type
4429221	TMT 120
4429421	TMT 120 S

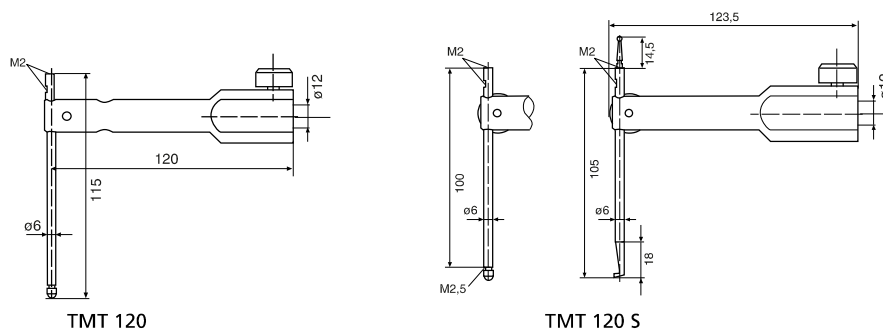

### ACCESSORIES

Order no.	Product name	Product type
4305870	Stylus $\varnothing$ 1.0 mm, carbide, $l = 14.5$ mm	800 ts
4305850	Stylus $\varnothing$ 2.0 mm, carbide, $l = 14.5$ mm	800 ts
4305871	Stylus $\varnothing$ 3.0 mm, carbide, $l = 14.5$ mm	800 ts
4309051	Stylus $\varnothing$ 2.0 mm, ruby, $l = 14.5$ mm	800 tsr
4360001	Standard contact point, steel, $r = 1.5$ mm	901
4360002	Standard contact point, carbide, $r = 1.5$ mm	901 H
4360003	Standard contact point, ruby, $r = 1.5$ mm	901 R
4360241	Pin contact point, carbide, $l = 11$ mm, measuring surface $\varnothing$ 1.5 mm	911 H2

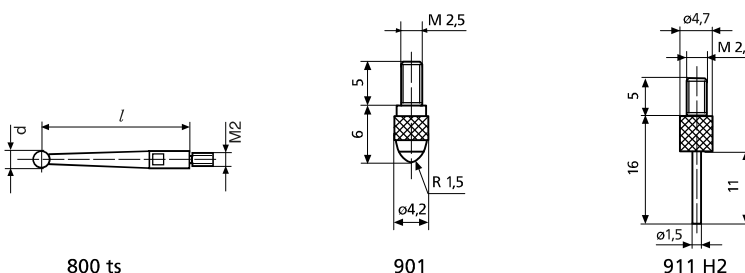

# Digimar 817 h3

## Carrier for checking perpendicularity

### FEATURES

- Carrier for perpendicularity measurement
- Suitable for analog and digital dial indicators
- Ideal with P1514H measuring probe (817 CLM only)



### TECHNICAL DATA

Order no.	Product type
4429206	817 h3

Order no.	Mounting hole
4429206	8 mm

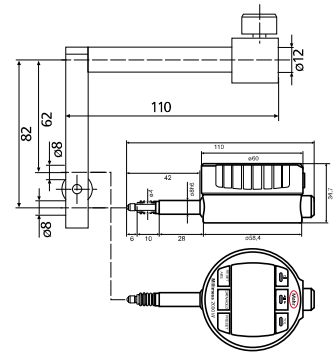

### ACCESSORIES

Order no.	Product name	Product type
4429610	Data connection cable RS232C (2 m)	DK-M1
4346700	Digital indicator 0.0001mm/±1mm	2000 W
4346800	Digital indicator 0.0001mm/±1mm	2001 W



2001 W



2000 W



DK-M1